

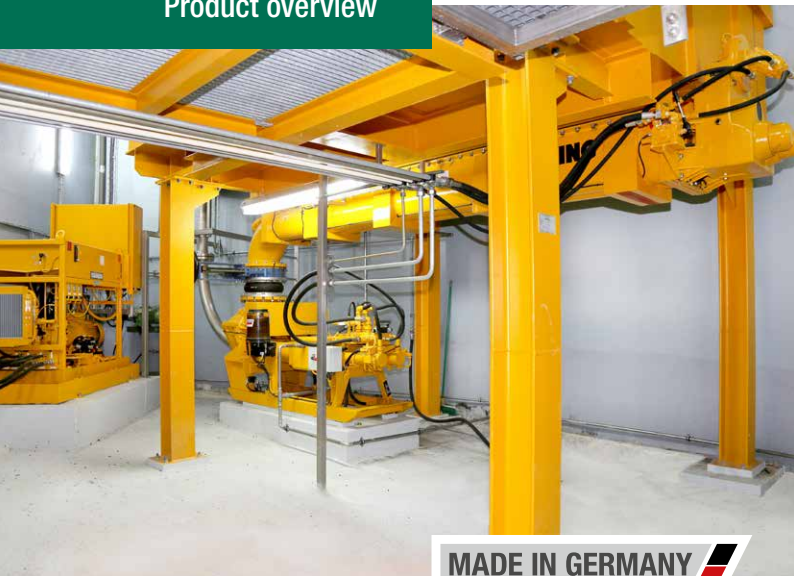

**SCHWING**  
**Stetter**

## Sludge pump systems

Product overview



**MADE IN GERMANY**  
by SCHWING-Stetter 

Output                    0.5 to 230 m<sup>3</sup>/h  
Design pressure        max. 150 bar



RECORD BREAKING ENGINEERING

# The benchmark for reliability.

Sludge pump systems from SCHWING.

Content	Page
<b>Sludge pumps (KSP)</b>	
KSP 12	10
EKSP 12	12
KSP 20	13
KSP 25	14
KSP 40	16
KSP 45	18
KSP 65	20
KSP 70	22
KSP 80	24
KSP 110	26
KSP 140	27
KSP 220	28
KSP 315	29
<b>Muck pumps (TAP)</b>	
TAP 30 / 50 / 90 / 110 / 140	30
<b>Double screw feeders (SD)</b>	
SD 250 / 350 / 500	32
<b>Hydraulic power packs (EHS)</b>	
EHS 100 - EHS 8000	34
<b>Control systems</b>	36
<b>Options and accessories</b>	38



# Countless applications. One system.

## Mining | Refineries | Power stations

- Red mud
- Gold sludge
- Iron sludge
- Zinc sludge
- Metal oxide sludge
- Tailings
- Fly ash
- ...

## Waste recycling

- Waste sludge
- Oil sludge
- Salt sludge
- radioactive waste

## Construction industry

- Bentonite
- Wet loam
- Backfilling grout in tunnel construction
- Tunnel muck
- Contaminated soil
- ...

## Sewage sludge

- Mechanically dewatered with and without foreign bodies
- Systems for sewage sludge incineration in cement works

## Dredging of bodies of water

- Dredged material
- Water sludge
- Silt

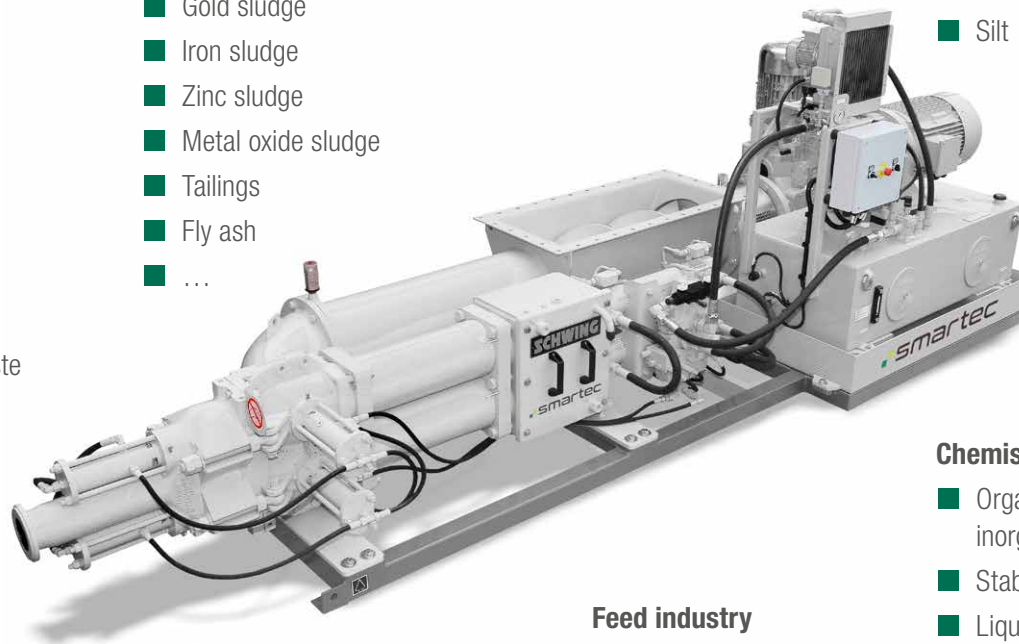

## Chemistry and industry

- Organic and inorganic substances
- Stabilised chemical waste
- Liquid lime sludge
- By-products of food production
- Paint sludge
- Pulp
- Carbonatation sludge

## Feed industry

- Animal feed
- Fish meal
- Abattoir by-products
- Animal waste

# Valve systems for sludge pumps

## Poppet valve system (STVE)

### Application

- pumping of fine-grained high-viscous materials

### Advantages

- reliable separation of the pressure side from the suction side during the switching prevents the backflow of the pumped medium from the pipeline into the pump
- quiet, low-pulsing pump operation
- low maintenance effort
- long lifetime

### Output

- up to 230 m<sup>3</sup>/h

### Output pressure

- up to 150 bar

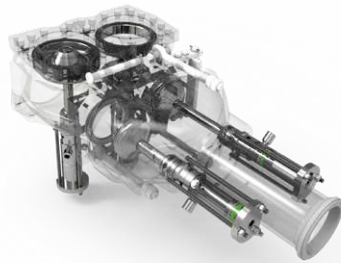

## ROCK valve system

### Application

- pumping of material with rough contaminations and large foreign bodies

### Advantages

- handling of foreign bodies of grain size up to 50 mm
- low maintenance effort
- long lifetime

### Output

- up to 130 m<sup>3</sup>/h

### Output pressure

- up to 100 bar



	Abbr.	KSP 12*	KSP 20	KSP 25	KSP 40	KSP 45	KSP 65	KSP 70	KSP 80	KSP 110	KSP 140	KSP 220	KSP 315
<b>STVE S</b>	S	1D / 2D	-	1D / 2D	1D / 2D	-	-	-	-	-	-	-	-
<b>STVE L</b>	L	1D / 2D	1D / 2D	1D / 2D	1D / 2D	1D / 2D	1D / 2D	1D / 2D	1D / 2D	1D / 2D	1D / 2D	1D / 2D	-
<b>STVE XL</b>	XL	-	-	-	-	1D	1D	1D	1D	1D	1D	1D	1D
<b>S-ROCK</b>	S-R	1D	-	1D	1D	-	-	-	-	-	-	-	-
<b>L-ROCK</b>	L-R	-	-	-	-	1D	1D	1D	1D	1D	1D	1D	-

\*also available as a single-piston pump (EKSP 12 with a single pressure outlet)

- 1D / 2D = sludge pump alternatively available with a single (1D) or double pressure outlet (2D)
- single pressure outlet (1D) with continuous pumping
- double pressure outlet (2D) with discontinuous pumping; delivery rate for each pressure outlet can be adjusted separately
- ROCK valve only available with a single pressure outlet (1D) due to its design

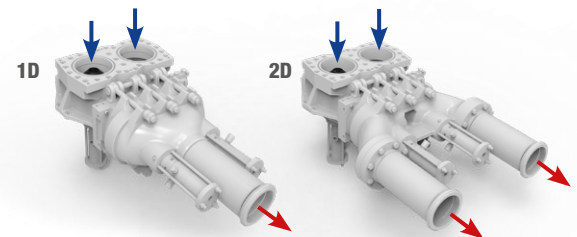

# Optimum adaptation. Maximum performance.

Depending on the installation situation (restricted spaces, building stock, material logistics, local conditions, etc.), horizontal or vertical arrangement of the sludge pump (KSP) is recommended. The arrangement of a potentially necessary double screw feeder (SD) for the sludge pump depends on the conveying material.

## Horizontal arrangement (sludge pump)



- material feed from above

## Vertical arrangement (sludge pump)



- side material feed
- cannot be combined with the ROCK valve system

The sludge pump (KSP) and double screw feeder (SD) can be arranged very flexibly. This allows for optimum adaptation to almost any situation. There may be installation and arrangement restrictions due to the properties of the medium being pumped.

The following figures show examples of the arrangement of the sludge pump and double screw feeder. Other arrangements are possible.

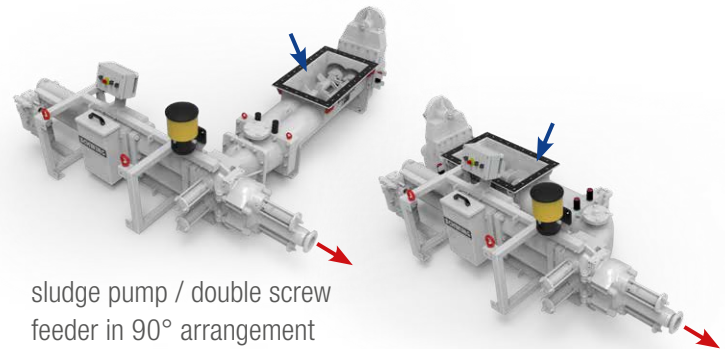

sludge pump / double screw feeder in 90° arrangement

sludge pump / double screw feeder in parallel arrangement

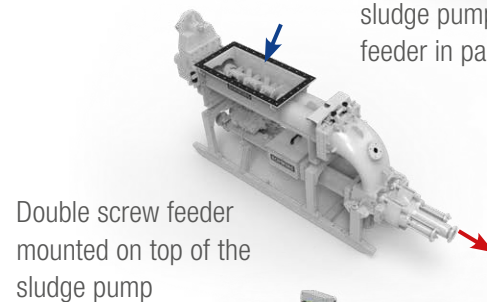

Double screw feeder mounted on top of the sludge pump

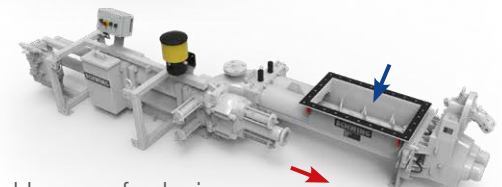

sludge pump / double screw feeder in S-arrangement (in-line arrangement)

# KSP 12



Designation	KSP 12			
<b>Performance</b>				
Output	m³/h	1 - 15	1 - 12.5	1 - 15
Output pressure max.	bar	75	75	70
<b>Pump kit</b>				
Delivery cylinders Ø	mm	180		
Stroke length	mm	500		
Delivery cylinder volume	l	12.5		
Differential cylinders Ø	mm	50/90		
Valve system		STVE-S	STVE-L	S-ROCK
Inlet	mm	2 x 125 <sup>1</sup>	2 x 210 <sup>1</sup>	740 x 300 <sup>2</sup>
Outlet	mm	2 x 100	2 x 150	-
Pressure outlet (D1 / D2) Ø	DN	100 / 2 x 100	180 / 2 x 180	125 / -
Grain size max.	mm	20*	40*	30
<b>Dimensions</b>				
Length	mm	2,800	3,200	2,400
Width	mm	700	1,000	1,000
Height	mm	900	1,200	1,050
Machine weight	kg	1,000	1,650	1,100

Designation	KSP 12 HD			
<b>Performance</b>				
Output	m³/h	1 - 15	1 - 12.5	1 - 15
Output pressure max.	bar	120	110	70
<b>Pump kit</b>				
Delivery cylinders Ø	mm	180		
Stroke length	mm	500		
Delivery cylinder volume	l	12.5		
Differential cylinders Ø	mm	80/125		
Valve system		STVE-S	STVE-L	S-ROCK
Inlet	mm	2 x 125 <sup>1</sup>	2 x 210 <sup>1</sup>	740 x 300 <sup>2</sup>
Outlet	mm	2 x 100	2 x 150	-
Pressure outlet (D1 / D2) Ø	DN	100 / 2 x 100	180 / 2 x 180	125 / -
Grain size max.	mm	20*	40*	30
<b>Dimensions</b>				
Length	mm	3,000	3,400	2,500
Width	mm	700	1,000	1,000
Height	mm	900	1,200	1,050
Machine weight	kg	1,250	1,750	1,150

- Pressure outlet with poppet unit (STVE) optionally available with a single pressure outlet 1D (with continuous pumping) or with a double pressure outlet 2D (with discontinuous pumping)
  - Delivery rate with double pressure outlet 2D can be adjusted individually for each pressure outlet
  - Delivery rate indicated at 100% degree of filling of the pumping cylinder and maximum stroke length (in practice: degree of filling depending on the consistency of the medium being pumped is between 70 and 90%)
  - Maximum delivery rate and maximum delivery pressure cannot be achieved simultaneously
  - Dimensions indicated for horizontal installation of the sludge pump; in the case of vertical installation, the height and width differ
  - Differential cylinder Ø: piston rod diameter/piston diameter
- \*max. 5% foreign matter content in the conveying material

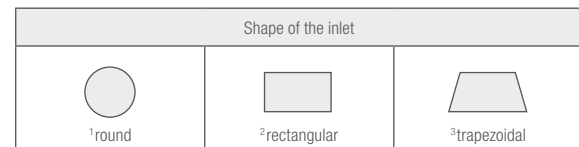

# EKSP 12

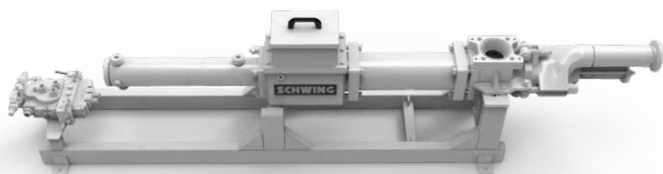

# KSP 20

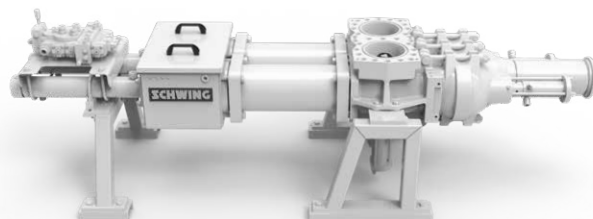

Designation	EKSP 12		EKSP 12 HD	
<b>Performance</b>				
Output	m <sup>3</sup> /h	0.5 - 7.5	0.5 - 7.5	
Output pressure max.	bar	75	120	
<b>Pump kit</b>				
Delivery cylinders Ø	mm	180	180	
Stroke length	mm	500	500	
Delivery cylinder volume	l	12.5	12.5	
Differential cylinders Ø	mm	50/90	80/125	
Valve system		STVE-S	STVE-S	
Inlet	mm	125 <sup>1</sup>	125 <sup>1</sup>	
Outlet	mm	100	100	
Pressure outlet (D1 / D2) Ø	DN	100 / -	100 / -	
Grain size max.	mm	20*	20*	
<b>Dimensions</b>				
Length	mm	3,500	3,500	
Width	mm	700	700	
Height	mm	900	900	
Machine weight	kg	650	700	

Designation	KSP 20	
<b>Performance</b>		
Output	m <sup>3</sup> /h	1 - 20
Output pressure max.	bar	40
<b>Pump kit</b>		
Delivery cylinders Ø	mm	230
Stroke length	mm	500
Delivery cylinder volume	l	20.5
Differential cylinders Ø	mm	50/90
Valve system		STVE-L
Inlet	mm	2 x 210 <sup>1</sup>
Outlet	mm	2 x 150
Pressure outlet (D1 / D2) Ø	DN	180 / 2 x 180
Grain size max.	mm	40*
<b>Dimensions</b>		
Length	mm	3,200
Width	mm	1,050
Height	mm	1,100
Machine weight	kg	1,500

- Pressure outlet with poppet unit (STVE) optionally available with a single pressure outlet 1D (with continuous pumping) or with a double pressure outlet 2D (with discontinuous pumping)
- Delivery rate with double pressure outlet 2D can be adjusted individually for each pressure outlet
- Delivery rate indicated at 100% degree of filling of the pumping cylinder and maximum stroke rate (in practice: degree of filling depending on the consistency of the medium being pumped is between 70 and 90%)
- Maximum delivery rate and maximum delivery pressure cannot be achieved simultaneously
- Dimensions indicated for horizontal installation of the sludge pump; in the case of vertical installation, the height and width differ
- Differential cylinder Ø: piston rod diameter/piston diameter
- \*max. 5% foreign matter content in the conveying material

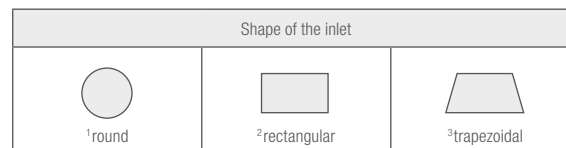

# KSP 25



Designation	KSP 25			
<b>Performance</b>				
Output	m³/h	1 - 30	1 - 25	1 - 30
Output pressure max.	bar	75	70	70
<b>Pump kit</b>				
Delivery cylinders Ø	mm	180		
Stroke length	mm	1,000		
Delivery cylinder volume	l	25.5		
Differential cylinders Ø	mm	50/90		
Valve system		STVE-S	STVE-L	S-ROCK
Inlet	mm	2 x 125 <sup>1</sup>	2 x 210 <sup>1</sup>	740 x 300 <sup>2</sup>
Outlet	mm	2 x 100	2 x 150	-
Pressure outlet (D1 / D2) Ø	DN	100 / 2 x 100	180 / 2 x 180	125 / -
Grain size max.	mm	20*	40*	30
<b>Dimensions</b>				
Length	mm	3,800	4,200	3,400
Width	mm	700	1,000	1,000
Height	mm	900	1,200	1,050
Machine weight	kg	1,100	1,850	1,200

Designation	KSP 25 HD				KSP 25 HDD
<b>Performance</b>					
Output	m³/h	1 - 30	1 - 25	1 - 30	1 - 25
Output pressure max.	bar	120	110	70	110
<b>Pump kit</b>					
Delivery cylinders Ø	mm	180			180
Stroke length	mm	1,000			1,000
Delivery cylinder volume	l	25.5			25.5
Differential cylinders Ø	mm	80/125			90/150
Valve system		STVE-S	STVE-L	S-ROCK	STVE-L
Inlet	mm	2 x 125 <sup>1</sup>	2 x 210 <sup>1</sup>	740 x 300 <sup>2</sup>	2 x 210 <sup>1</sup>
Outlet	mm	2 x 100	2 x 150	-	2 x 150
Pressure outlet (D1/D2) Ø	DN	100 / 2 x 100	180 / 2 x 180	125 / -	180 / -
Grain size max.	mm	20*	40*	30	40*
<b>Dimensions</b>					
Length	mm	4,000	4,400	3,500	4,350
Width	mm	700	1,000	1,000	1,000
Height	mm	900	1,200	1,050	1,300
Machine weight	kg	1,500	2,000	1,400	2,300

- Pressure outlet with poppet unit (STVE) optionally available with a single pressure outlet 1D (with continuous pumping) or with a double pressure outlet 2D (with discontinuous pumping)
- Delivery rate with double pressure outlet 2D can be adjusted individually for each pressure outlet
- Delivery rate indicated at 100% degree of filling of the pumping cylinder and maximum stroke length (in practice: degree of filling depending on the consistency of the medium being pumped is between 70 and 90%)
- Maximum delivery rate and maximum delivery pressure cannot be achieved simultaneously
- Dimensions indicated for horizontal installation of the sludge pump; in the case of vertical installation, the height and width differ
- Differential cylinder Ø: piston rod diameter/piston diameter
- \*max. 5% foreign matter content in the conveying material

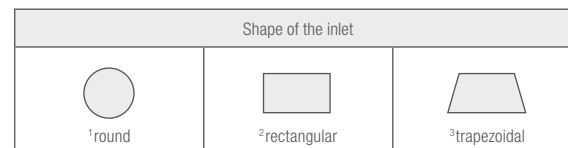

# KSP 40



Designation	KSP 40		
<b>Performance</b>			
Output	m <sup>3</sup> /h	1 - 35	1 - 35
Output pressure max.	bar	75	70
<b>Pump kit</b>			
Delivery cylinders Ø	mm	180	
Stroke length	mm	1,600	
Delivery cylinder volume	l	40.5	
Differential cylinders Ø	mm	50/90	
Valve system		STVE-S	S-ROCK
Inlet	mm	2 x 125 <sup>1</sup>	740 x 300 <sup>2</sup>
Outlet	mm	2 x 100	-
Pressure outlet (D1 / D2) Ø	DN	100 / 2 x 100	125 / -
Grain size max.	mm	20*	30
<b>Dimensions</b>			
Length	mm	5,000	4,600
Width	mm	700	1,000
Height	mm	900	1,050
Machine weight	kg	1,200	1,300

Designation	KSP 40 HD			KSP 40 HDD
<b>Performance</b>				
Output	m <sup>3</sup> /h	1 - 35	1 - 35	1 - 35
Output pressure max.	bar	120	70	110
<b>Pump kit</b>				
Delivery cylinders Ø	mm	180		180
Stroke length	mm	1,600		1,600
Delivery cylinder volume	l	40.5		40.5
Differential cylinders Ø	mm	80/125		90/150
Valve system		STVE-S	S-ROCK	STVE-L
Inlet	mm	2 x 125 <sup>1</sup>	740 x 300 <sup>2</sup>	2 x 210 <sup>1</sup>
Outlet	mm	2 x 100	-	2 x 150
Pressure outlet (D1 / D2) Ø	DN	100 / 2 x 100	125 / -	180 / -
Grain size max.	mm	20*	30	40*
<b>Dimensions</b>				
Length	mm	5,200	4,800	5,550
Width	mm	700	1,000	1,000
Height	mm	900	1,050	1,300
Machine weight	kg	1,650	1,550	2,450

- Pressure outlet with poppet unit (STVE) optionally available with a single pressure outlet 1D (with continuous pumping) or with a double pressure outlet 2D (with discontinuous pumping)
- Delivery rate with double pressure outlet 2D can be adjusted individually for each pressure outlet
- Delivery rate indicated at 100% degree of filling of the pumping cylinder and maximum stroke length (in practice: degree of filling depending on the consistency of the medium being pumped is between 70 and 90%)
- Maximum delivery rate and maximum delivery pressure cannot be achieved simultaneously
- Dimensions indicated for horizontal installation of the sludge pump; in the case of vertical installation, the height and width differ
- Differential cylinder Ø: piston rod diameter/piston diameter
- \*max. 5% foreign matter content in the conveying material

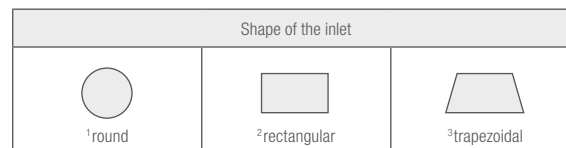

# KSP 45



Designation	KSP 45		
<b>Performance</b>			
Output	m <sup>3</sup> /h	2 - 40	2 - 40
Output pressure max.	bar	80	80
<b>Pump kit</b>			
Delivery cylinders Ø	mm	230	
Stroke length	mm	1,000	
Delivery cylinder volume	l	41.5	
Differential cylinders Ø	mm	80/125	
Valve system		STVE-L	L-ROCK
Inlet	mm	2 x 210 <sup>1</sup>	792/630 x 330 <sup>3</sup>
Outlet	mm	2 x 150	-
Pressure outlet (D1 / D2) Ø	DN	180 / 2 x 180	150 / -
Grain size max.	mm	40*	50
<b>Dimensions</b>			
Length	mm	4,350	4,000
Width	mm	1,000	1,350
Height	mm	1,300	1,100
Machine weight	kg	2,300	2,550

Designation	KSP 45 HD			
<b>Performance</b>				
Output	m <sup>3</sup> /h	2 - 40	2 - 30	2 - 40
Output pressure max.	bar	110	110	100
<b>Pump kit</b>				
Delivery cylinders Ø	mm	230		
Stroke length	mm	1,000		
Delivery cylinder volume	l	41.5		
Differential cylinders Ø	mm	90/150		
Valve system		STVE-L	STVE-XL	L-ROCK
Inlet	mm	2 x 125 <sup>1</sup>	2 x 280 <sup>1</sup>	792/630 x 330 <sup>3</sup>
Outlet	mm	2 x 150	2 x 250	-
Pressure outlet (D1 / D2) Ø	DN	180 / 2 x 180	200 / -	150 / -
Grain size max.	mm	40*	60*	50
<b>Dimensions</b>				
Length	mm	4,350	5,100	4,000
Width	mm	1,000	1,450	1,350
Height	mm	1,300	1,500	1,100
Machine weight	kg	2,400	5,000	2,650

- Pressure outlet with poppet unit (STVE) optionally available with a single pressure outlet 1D (with continuous pumping) or with a double pressure outlet 2D (with discontinuous pumping)
- Delivery rate with double pressure outlet 2D can be adjusted individually for each pressure outlet
- Delivery rate indicated at 100% degree of filling of the pumping cylinder and maximum stroke length (in practice: degree of filling depending on the consistency of the medium being pumped is between 70 and 90%)
- Maximum delivery rate and maximum delivery pressure cannot be achieved simultaneously
- Dimensions indicated for horizontal installation of the sludge pump; in the case of vertical installation, the height and width differ
- Differential cylinder Ø: piston rod diameter/piston diameter
- \*max. 5% foreign matter content in the conveying material

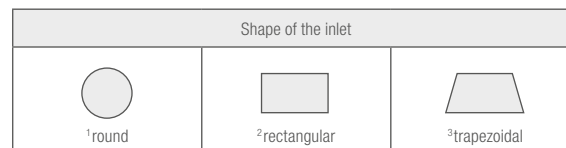

# KSP 65



Designation	KSP 65		
<b>Performance</b>			
Output	m <sup>3</sup> /h	2 - 55	2 - 55
Output pressure max.	bar	80	80
<b>Pump kit</b>			
Delivery cylinders Ø	mm	230	
Stroke length	mm	1,600	
Delivery cylinder volume	l	66.5	
Differential cylinders Ø	mm	80/125	
Valve system		STVE-L	L-ROCK
Inlet	mm	2 x 210 <sup>1</sup>	792/630 x 330 <sup>3</sup>
Outlet	mm	2 x 150	-
Pressure outlet (D1 / D2) Ø	DN	180 / 2 x 180	150 / -
Grain size max.	mm	40*	50
<b>Dimensions</b>			
Length	mm	5,550	5,200
Width	mm	1,000	1,350
Height	mm	1,300	1,100
Machine weight	kg	2,800	3,050

Designation	KSP 65 HD				KSP 65 HDD
<b>Performance</b>					
Output	m <sup>3</sup> /h	2 - 55	2 - 50	2 - 55	2 - 50
Output pressure max.	bar	110	110	100	130
<b>Pump kit</b>					
Delivery cylinders Ø	mm	230			230
Stroke length	mm	1,600			1,600
Delivery cylinder volume	l	66.5			66.5
Differential cylinders Ø	mm	90/150			140/200
Valve system		STVE-L	STVE-XL	L-ROCK	STVE-XL
Inlet	mm	2 x 210 <sup>1</sup>	2 x 280 <sup>1</sup>	792/630 x 330 <sup>3</sup>	2 x 280 <sup>1</sup>
Outlet	mm	2 x 150	2 x 250	-	2 x 250
Pressure outlet (D1 / D2) Ø	DN	180 / 2 x 180	200 / -	150 / -	200 / -
Grain size max.	mm	40*	60*	50	60*
<b>Dimensions</b>					
Length	mm	5,550	6,450	5,200	6,450
Width	mm	1,000	1,450	1,350	1,450
Height	mm	1,300	1,500	1,100	1,500
Machine weight	kg	3,100	5,400	3,350	6,100

- Pressure outlet with poppet unit (STVE) optionally available with a single pressure outlet 1D (with continuous pumping) or with a double pressure outlet 2D (with discontinuous pumping)
  - Delivery rate with double pressure outlet 2D can be adjusted individually for each pressure outlet
  - Delivery rate indicated at 100% degree of filling of the pumping cylinder and maximum stroke rate (in practice: degree of filling depending on the consistency of the medium being pumped is between 70 and 90%)
  - Maximum delivery rate and maximum delivery pressure cannot be achieved simultaneously
  - Dimensions indicated for horizontal installation of the sludge pump; in the case of vertical installation, the height and width differ
  - Differential cylinder Ø: piston rod diameter/piston diameter
- \*max. 5% foreign matter content in the conveying material

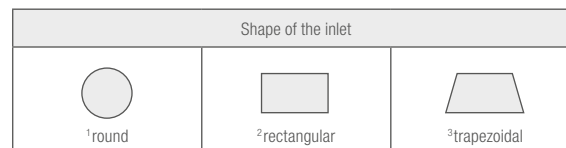

# KSP 70



Designation	KSP 70		
<b>Performance</b>			
Output	m <sup>3</sup> /h	5 - 65	5 - 65
Output pressure max.	bar	65	65
<b>Pump kit</b>			
Delivery cylinders Ø	mm	300	
Stroke length	mm	1,000	
Delivery cylinder volume	l	70.5	
Differential cylinders Ø	mm	90/150	
Valve system		STVE-L	L-ROCK
Inlet	mm	2 x 210 <sup>1</sup>	792/630 x 330 <sup>3</sup>
Outlet	mm	2 x 150	-
Pressure outlet (D1 / D2) Ø	DN	180 / 2 x 180	150 / -
Grain size max.	mm	40*	50
<b>Dimensions</b>			
Length	mm	4,250	3,900
Width	mm	1,450	1,350
Height	mm	1,400	1,100
Machine weight	kg	3,800	4,050

Designation	KSP 70 HD		
<b>Performance</b>			
Output	m <sup>3</sup> /h	5 - 55	
Output pressure max.	bar	125	
<b>Pump kit</b>			
Delivery cylinders Ø	mm	300	
Stroke length	mm	1,000	
Delivery cylinder volume	l	70.5	
Differential cylinders Ø	mm	140/200	
Valve system		STVE-XL	
Inlet	mm	2 x 280 <sup>1</sup>	
Outlet	mm	2 x 250	
Pressure outlet (D1 / D2) Ø	DN	200 / -	
Grain size max.	mm	60*	
<b>Dimensions</b>			
Length	mm	5,150	
Width	mm	1,450	
Height	mm	1,800	
Machine weight	kg	4,900	

- Pressure outlet with poppet unit (STVE) optionally available with a single pressure outlet 1D (with continuous pumping) or with a double pressure outlet 2D (with discontinuous pumping)
- Delivery rate with double pressure outlet 2D can be adjusted individually for each pressure outlet
- Delivery rate indicated at 100% degree of filling of the pumping cylinder and maximum stroke length (in practice: degree of filling depending on the consistency of the medium being pumped is between 70 and 90%)
- Maximum delivery rate and maximum delivery pressure cannot be achieved simultaneously
- Dimensions indicated for horizontal installation of the sludge pump; in the case of vertical installation, the height and width differ
- Differential cylinder Ø: piston rod diameter/piston diameter
- \*max. 5% foreign matter content in the conveying material

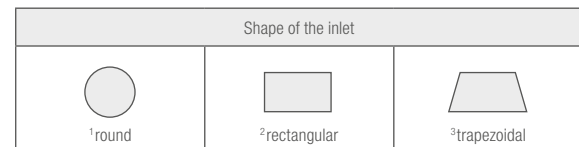

# KSP 80



Designation	KSP 80		
<b>Performance</b>			
Output	m <sup>3</sup> /h	2 - 55	2 - 55
Output pressure max.	bar	80	80
<b>Pump kit</b>			
Delivery cylinders Ø	mm	230	
Stroke length	mm	2,000	
Delivery cylinder volume	l	83.0	
Differential cylinders Ø	mm	80/125	
Valve system		STVE-L	L-ROCK
Inlet	mm	2 x 210 <sup>1</sup>	792/630 x 330 <sup>3</sup>
Outlet	mm	2 x 150	-
Pressure outlet (D1 / D2) Ø	DN	180 / 2 x 180	150 / -
Grain size max.	mm	40*	50
<b>Dimensions</b>			
Length	mm	6,350	6,000
Width	mm	1,000	1,350
Height	mm	1,300	1,100
Machine weight	kg	3,200	3,450

Designation	KSP 80 HD			
<b>Performance</b>				
Output	m <sup>3</sup> /h	2 - 55	2 - 55	2 - 55
Output pressure max.	bar	110	110	100
<b>Pump kit</b>				
Delivery cylinders Ø	mm	230		
Stroke length	mm	2,000		
Delivery cylinder volume	l	83.0		
Differential cylinders Ø	mm	90/150		
Valve system		STVE-L	STVE-XL	L-ROCK
Inlet	mm	2 x 210 <sup>1</sup>	2 x 280 <sup>1</sup>	792/630 x 330 <sup>3</sup>
Outlet	mm	2 x 150	2 x 250	-
Pressure outlet (D1 / D2) Ø	DN	180 / 2 x 180	200 / -	150 / -
Grain size max.	mm	40*	60*	50
<b>Dimensions</b>				
Length	mm	6,350	7,150	6,000
Width	mm	1,000	1,450	1,350
Height	mm	1,300	1,500	1,100
Machine weight	kg	3,500	5,800	3,750

- Pressure outlet with poppet unit (STVE) optionally available with a single pressure outlet 1D (with continuous pumping) or with a double pressure outlet 2D (with discontinuous pumping)
- Delivery rate with double pressure outlet 2D can be adjusted individually for each pressure outlet
- Delivery rate indicated at 100% degree of filling of the pumping cylinder and maximum stroke rate (in practice: degree of filling depending on the consistency of the medium being pumped is between 70 and 90%)
- Maximum delivery rate and maximum delivery pressure cannot be achieved simultaneously
- Dimensions indicated for horizontal installation of the sludge pump; in the case of vertical installation, the height and width differ
- Differential cylinder Ø: piston rod diameter/piston diameter
- \*max. 5% foreign matter content in the conveying material

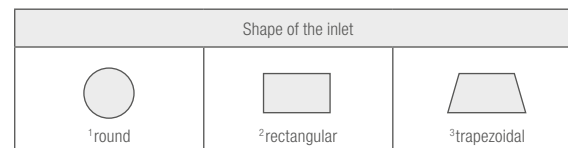

# KSP 110

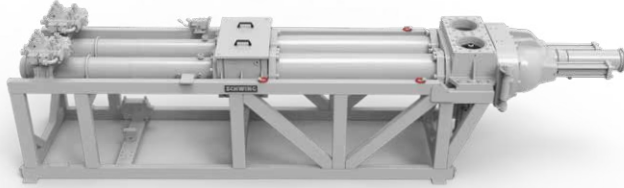

# KSP 140



Designation	KSP 110			
<b>Performance</b>				
Output	m <sup>3</sup> /h	5 - 110	5 - 90	5 - 110
Output pressure max.	bar	110	130	100
<b>Pump kit</b>				
Delivery cylinders Ø	mm	300		
Stroke length	mm	1,600		
Delivery cylinder volume	l	113.0		
Differential cylinders Ø	mm	140/200		
Valve system		STVE-L	STVE-XL	L-ROCK
Inlet	mm	2 x 210 <sup>1</sup>	2 x 280 <sup>1</sup>	792/630 x 330 <sup>3</sup>
Outlet	mm	2 x 150	2 x 250	-
Pressure outlet (D1 / D2) Ø	DN	180 / 2 x 180	200 / -	150 / -
Grain size max.	mm	40*	60*	50
<b>Dimensions</b>				
Length	mm	6,200	6,500	5,650
Width	mm	1,450	1,450	1,450
Height	mm	1,400	1,800	1,400
Machine weight	kg	4,600	6,200	4,800

Designation	KSP 140			
<b>Performance</b>				
Output	m <sup>3</sup> /h	5 - 135	5 - 110	5 - 135
Output pressure max.	bar	110	130	100
<b>Pump kit</b>				
Delivery cylinders Ø	mm	300		
Stroke length	mm	2,000		
Delivery cylinder volume	l	141.5		
Differential cylinders Ø	mm	140/200		
Valve system		STVE-L	STVE-XL	L-ROCK
Inlet	mm	2 x 210 <sup>1</sup>	2 x 280 <sup>1</sup>	792/630 x 330 <sup>3</sup>
Outlet	mm	2 x 150	2 x 250	-
Pressure outlet (D1 / D2) Ø	DN	180 / 2 x 180	200 / -	150 / -
Grain size max.	mm	40*	60*	50
<b>Dimensions</b>				
Length	mm	7,000	7,300	6,450
Width	mm	1,450	1,450	1,450
Height	mm	1,400	1,800	1,400
Machine weight	kg	4,700	7,000	5,250

- Pressure outlet with poppet unit (STVE) optionally available with a single pressure outlet 1D (with continuous pumping) or with a double pressure outlet 2D (with discontinuous pumping)
- Delivery rate with double pressure outlet 2D can be adjusted individually for each pressure outlet
- Delivery rate indicated at 100% degree of filling of the pumping cylinder and maximum stroke length (in practice: degree of filling depending on the consistency of the medium being pumped is between 70 and 90%)
- Maximum delivery rate and maximum delivery pressure cannot be achieved simultaneously
- Dimensions indicated for horizontal installation of the sludge pump; in the case of vertical installation, the height and width differ
- Differential cylinder Ø: piston rod diameter/piston diameter
- \*max. 5% foreign matter content in the conveying material

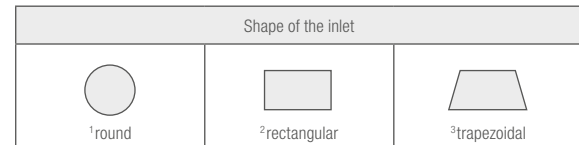

# KSP 220



# KSP 315



Designation	KSP 220			
<b>Performance</b>				
Output	m <sup>3</sup> /h	5 - 140	5 - 140	5 - 140
Output pressure max.	bar	110	130	100
<b>Pump kit</b>				
Delivery cylinders Ø	mm	300		
Stroke length	mm	3,100		
Delivery cylinder volume	l	219		
Differential cylinders Ø	mm	140/200		
Valve system		STVE-L	STVE-XL	L-ROCK
Inlet	mm	2 x 210 <sup>1</sup>	2 x 280 <sup>1</sup>	792/630 x 330 <sup>3</sup>
Outlet	mm	2 x 150	2 x 250	-
Pressure outlet (D1 / D2) Ø	DN	180 / 2 x 180	200 / -	150 / -
Grain size max.	mm	40*	60*	50
<b>Dimensions</b>				
Length	mm	9,200	9,500	8,650
Width	mm	1,450	1,450	1,450
Height	mm	1,400	1,800	1,400
Machine weight	kg	5,700	7,350	6,050

Designation	KSP 315		KSP 315-SSC
<b>Performance</b>			
Output	m <sup>3</sup> /h	20 - 230	20 - 200
Output pressure max.	bar	150	150
<b>Pump kit</b>			
Delivery cylinders Ø	mm	360	360
Stroke length	mm	3,100	3,100
Delivery cylinder volume	l	315.5	315.5
Differential cylinders Ø	mm	160/250	160/250
Valve system		STVE-XL	STVE-XL
Inlet	mm	2 x 280 <sup>1</sup>	2 x 280 <sup>1</sup>
Outlet	mm	2 x 250	2 x 250
Pressure outlet (D1 / D2) Ø	DN	250 / -	250 / -
Grain size max.	mm	60*	60*
<b>Dimensions</b>			
Length	mm	11,500	11,500
Width	mm	1,900	1,900
Height	mm	2,100	2,100
Machine weight	kg	16,000	16,000

- Pressure outlet with poppet unit (STVE) optionally available with a single pressure outlet 1D (with continuous pumping) or with a double pressure outlet 2D (with discontinuous pumping)
- Delivery rate with double pressure outlet 2D can be adjusted individually for each pressure outlet
- Delivery rate indicated at 100% degree of filling of the pumping cylinder and maximum stroke length (in practice: degree of filling depending on the consistency of the medium being pumped is between 70 and 90%)
- Maximum delivery rate and maximum delivery pressure cannot be achieved simultaneously
- Dimensions indicated for horizontal installation of the sludge pump; in the case of vertical installation, the height and width differ
- Differential cylinder Ø: piston rod diameter/piston diameter
- \*max. 5% foreign matter content in the conveying material

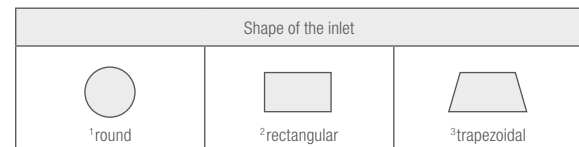



# Muck pumps (TAP)



Designation	TAP 30	TAP 50	TAP 90	Designation	TAP 110	TAP 140
<b>Performance</b>				<b>Performance</b>		
Output	m <sup>3</sup> /h 3 - 30	5 - 50	9 - 90	Output	m <sup>3</sup> /h 11 - 110	14 - 140
Output pressure max.	bar 70 (HD: 100)	70 (HD: 100)	70 (HD: 100)	Output pressure max.	bar 70 (HD: 100)	70 (HD: 100)
<b>Pump kit</b>				<b>Pump kit</b>		
Delivery cylinders Ø	mm 230	300	300	Delivery cylinders Ø	mm 300	300
Stroke length	mm 700	500	1,000	Stroke length	mm 1,600	2,000
Delivery cylinder volume	l 29.0	35.5	70.5	Delivery cylinder volume	l 113.0	141.5
Differential cylinders Ø	mm 90/150	90/150	90/150	Differential cylinders Ø	mm 90/150	90/150
Valve system	L-ROCK	L-ROCK	L-ROCK	Valve system	L-ROCK	L-ROCK
Inlet	mm 792/630x330 <sup>3</sup>	792/630x330 <sup>3</sup>	792/630x330 <sup>3</sup>	Inlet	mm 792/630x330 <sup>3</sup>	792/630x330 <sup>3</sup>
Outlet	mm -	-	-	Outlet	mm -	-
Pressure outlet (D1 / D2) Ø DN	150	150	150	Pressure outlet (D1 / D2) Ø DN	150	150
Grain size max.	mm 50	50	50	Grain size max.	mm 50	50
<b>Dimensions</b>				<b>Dimensions</b>		
Length	mm 3,350	3,200	4,200	Length	mm 5,400	6,400
Width	mm 1,350	1,350	1,350	Width	mm 1,350	1,350
Height	mm 900	1,000	1,100	Height	mm 1,100	1,200
Machine weight	kg 2,500	2,700	3,400	Machine weight	kg 3,700	4,200

- Delivery rate indicated at 100% degree of filling of the pumping cylinder and maximum stroke rate (in practice: degree of filling depending on the consistency of the medium being pumped is between 70 and 90%)
- Maximum delivery rate and maximum delivery pressure cannot be achieved simultaneously
- Dimensions indicated for horizontal installation of the sludge pump; in the case of vertical installation, the height and width differ
- Differential cylinder Ø: piston rod diameter/piston diameter
- the arrangement of the pump kit and the position of the hydraulics and the frame can be adapted to the structural conditions on request

Shape of the inlet		
 <sup>1</sup> round	 <sup>2</sup> rectangular	 <sup>3</sup> trapezoidal

# Double screw feeders (SD)

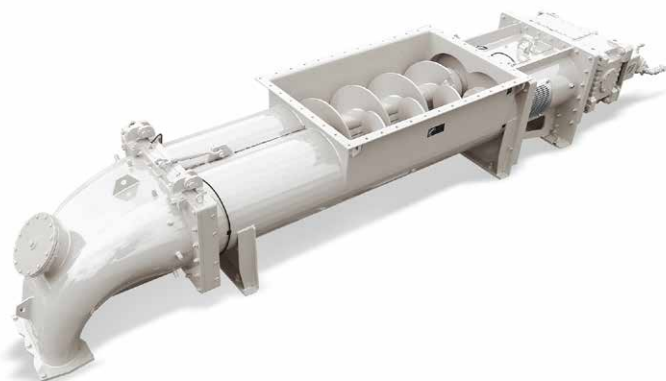

Designation		SD 250	SD 250 HD	SD 350	SD 350 HD	SD 500	SD 500 HD
Performance							
Output	m <sup>3</sup> /h	0.4 - 16	0.4 - 16	1 - 40	1 - 40	5 - 113	5 - 108
Output pressure	bar	3	5	2.5	6	3	6
Inlet opening							
Length	mm	from 500	from 500	from 500	from 500	from 500	from 500
Width	mm	400	400	600	600	880	880

- Double screw feeders homogenise the pumping medium, ensuring a high degree of filling of the delivery cylinder through a continuous supply to the sludge pump and thus also enable a high output rate for highly viscous materials
- The output rate and output pressure depend on the conveying material and the efficiency (degree of filling + slip) of the double screw feeder (output rates indicated at 40% efficiency)
- Double screw feeder can optionally be front- or rear-driven (rear-drive as standard, front-drive in the case of space restrictions on the rear side of the SD)

- Output pressure: theoretical pre-press pressure at the outlet of the double screw feeder before the sludge pump inlet
- Inlet openings can be delivered from a length of 500 mm upwards and with a DN flange (length variations at intervals of 100 mm; special lengths available on request)
- Dimensions and weights depend on the length of the inlet opening and the design of the outlet

# Hydraulic power packs (EHS)



Designation	<b>EHS 100 - EHS 8000</b>	
Drive power	kW	5.5 - 1,600 (2 x 800)
Hydraulic tank	l	100 - 8,000
Oil cooler		air-cooled / water-cooled*

\*water connection is required and must be supplied by the customer

- Development and production of the electro-hydraulic power packs (EHS) by SCHWING in Germany
- Optimum dimensioning of the drive system and careful matching to the pump system guarantee high efficiency, reliability and maximum performance
- Control via electrical control in the local switch cabinet and/or via the central control room
- Electric motors generally correspond to the highest efficiency class
- The hydraulic power pack can be equipped with a leak-oil pan (drip protection) or an oil collecting pan (reception of all hydraulic oil) on request

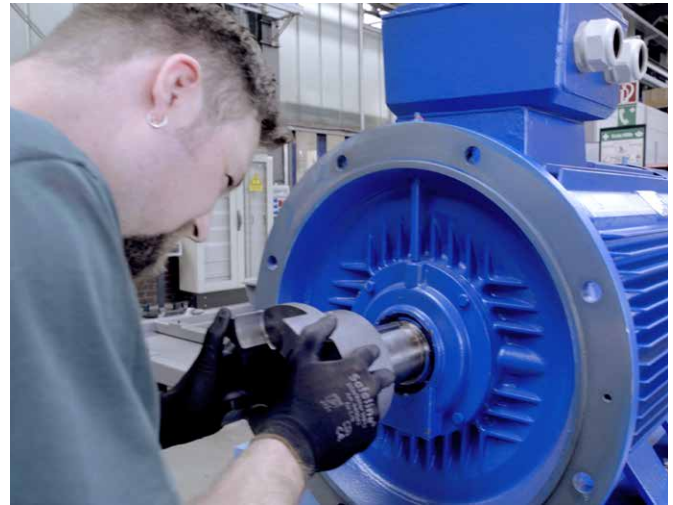

# Control systems



- Development and production of the controls by SCHWING in Germany
- The range of services includes consultation, planning, engineering, delivery and installation of the control
- Programmable logic controller (PLC) by Siemens as standard (also other manufacturers on request)
- Electric controls for systems of 5.5 to 1,000 kW
- Fully automatic control, regulation and monitoring of the sludge pump operation
- Display and operation via a colour touchscreen
- Remote control of the control room, switchgear in accordance with all international standards
- Easy integration into existing systems



# Options and accessories

## Everything from one source.

### Measurement technology

- Level indication (level measuring)
- Pressure transducer (pressure measuring)
- Pressure transmitter (dry-run protection)
- Soft-push control (EHU)
- ...

### Silo technology

- Storage silo
- Reception bunker
- Discharge system sliding frame
- Discharge screw conveyors
- Rectangular valves
- Compensators, angular
- Fluidisation
- ...

### Software

- Stroke valve control
- Output rate measurement
- Process control
- ...

### Equipment

- Pipeline
- Coarse particle separator
- Lubricant dosing system
- Vertical agitator
- Reservoir tank
- Shut-off valve
- Ball valves
- Tube branches
- Intermediate flange valves, round
- Compensators, round
- Pig (sponge ball)
- Coupling system
- DIN flanges and special flanges
- Sound insulation
- Central lubricating system
- ...

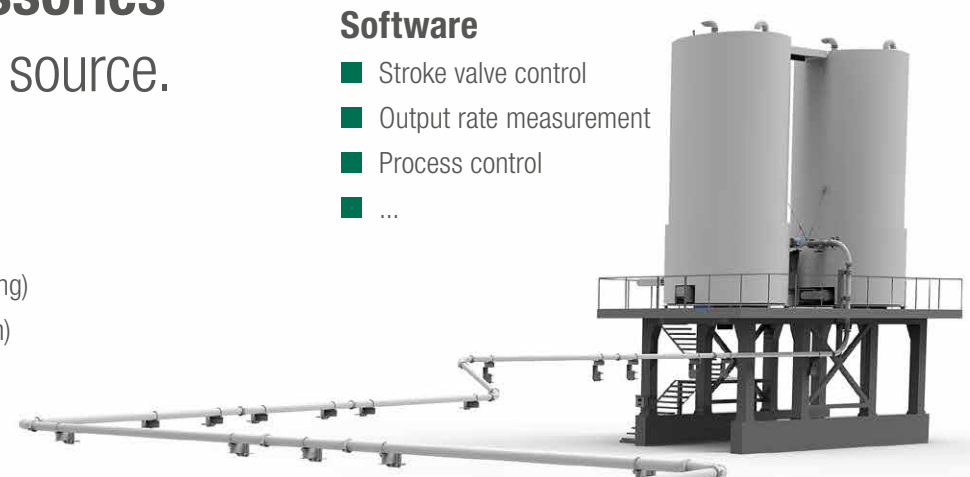
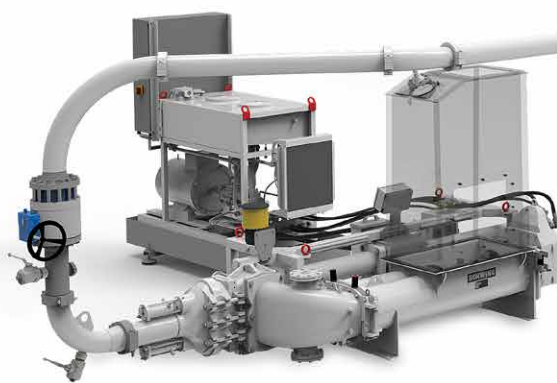

SCHWING sludge pumps.  
The benchmark for reliability.



Animation  
poppet valve system (STVE)



Animation  
ROCK valve system



**SCHWING**  
**Stetter**

SCHWING GmbH  
Heerstrasse 9-27  
44653 Herne, Germany  
Fon +49 23 25 - 987-0  
Fax +49 23 25 - 72922  
info@schwing.de  
www.schwing-stetter.com

Stetter GmbH  
Dr.-Karl-Lenz-Strasse 70  
87700 Memmingen, Germany  
Fon +49 83 31 - 78-0  
Fax +49 83 31 - 78 275  
info@stetter.de  
www.schwing-stetter.com

Subject to technical and dimensional modifications. Illustrations are non-binding.  
The exact standard specification, the scope of delivery and the technical data are detailed in the offer.